



Proven Performance and Reliability

SCPP 1 Circumferential Piston Pump

Application

The SCPP range of positive displacement pumps has been designed for use in a wide range of applications within: Dairy, Food, Beverage, Pharma and Personal Care markets. The highly efficient design is particularly suited to applications that are low in viscosity with medium to high discharge pressures.

Standard Design

Pump Gearbox The SCPP pump with its circumferential piston pump design concept has a cast iron gearbox which provides maximum shaft rigidity. Gear box is powder-coated. Stainless steel gear box is optional on models 006, 015, 018, 030, 045, 060 & 130. One-piece 316L stainless steel shafts are standard on models 006, 015 & 018. High-strength 17-4 PH one-piece shafts are standard on models 030, 045, 060, 130, 220 & 320. Four-way mounting allows horizontal or vertical porting and provides mounting flexibility.

Pumphead Construction The SCPP in standard specification has pump casing in AISI 316 stainless steel with an internal surface finish of Ra 32/Ra 0.8 complying to 3A standards. Rotors are made of special non-galling alloy and are available as standard with twin-wing form or optionally with single wing for handling large solids. Seal options include single O-ring seal, single mechanical seal, double O-ring seal with flush, or double mechanical seal with flush.



SCPP 1 Model	Nominal Capacity		Displacement per Revolution		Maximum Pressure		Temperature Range		Standard Ports		Optional Ports		Maximum Speed (RPM)
	M ³ /hr	US	Litre	US	Bar	PSI	Deg. C	Deg. F	mm	in.	mm	in.	
		GPM		Gal.									
006	1.3	6.0	0.030	0.008	14	200	-40° to 150°	-40° to 300°	25	1.0	38.0	1.5	800
015	2.0	9.0	0.052	0.014	14	200	-40° to 150°	-40° to 300°	38	1.5	-	-	700
018	3.8	17.0	0.110	0.030	14	200	-40° to 150°	-40° to 300°	38	1.5	51.0	2.0	600
030	8.2	36.0	0.230	0.060	14	200	-40° to 150°	-40° to 300°	38	1.5	51.0	2.0	600
045	13.3	59.0	0.380	0.100	27	400	-40° to 150°	-40° to 300°	51	2.0	-	-	600
060	20.4	90.0	0.580	0.150	14	200	-40° to 150°	-40° to 300°	64	2.5	76.0	3.0	600
130	34.1	150.0	0.960	0.250	14	200	-40° to 150°	-40° to 300°	76	3.0	-	-	600
220	70.4	310.0	1.980	0.520	14	200	-40° to 150°	-40° to 300°	102	4.0	-	-	600
320	102.0	450.0	2.850	0.750	14	200	-40° to 150°	-40° to 300°	152	6.0	-	-	600

SCPP 1 Rectangular Flange Model	Nominal Capacity		Displacement per Revolution		Maximum Pressure		Temperature Range		Inlet (W x L)		Outlet		Maximum Speed (RPM)
	M ³ /hr	US	Litre	US	Bar	PSI	Deg. C	Deg. F	mm	in.	mm	in.	
		GPM		Gal.									
034	5.4	24.0	0.22	0.06	14	200	-40° to 150°	-40° to 300°	44.50 x 171.45	1.75 x 6.75	50.8	2.0	400
064	13.6	60.0	0.57	0.15	14	200	-40° to 150°	-40° to 300°	56.90 x 224.03	2.24 x 8.82	57.2	2.5	400
134	22.7	100.0	0.96	0.25	14	200	-40° to 150°	-40° to 300°	75.44 x 234.95	2.97 x 9.25	76.2	3.0	400
224	45.4	200.0	1.97	0.52	14	200	-40° to 150°	-40° to 300°	98.30 x 279.40	3.87 x 11.00	101.6	4.0	400

Hot clearances required for high temperature operation.

Materials of Construction

Pump gearbox – high quality grey cast iron. Pumphead – product wetted components in 316L and rotors in special non-galling material. Product wetted elastomers EPDM, NBR, FPM all FDA conforming.

Shaft Sealing Options

...for different liquids and conditions of service

Single O-Ring Seals

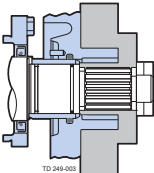

- Standard O-rings and Cover Seals:	Buna
- Optional O-rings and Cover Seals:	FPM, EPDM, Silicone

TD 249-003

Double O-Ring Seals with Flush

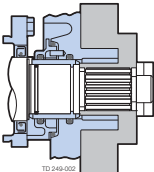

- Standard O-rings and Cover Seals:	Buna
- Optional O-rings and Cover Seals:	FPM, EPDM, Silicone

TD 249-002

Single Mechanical Seals

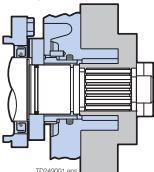

- Standard Seal Faces:	SiC/SiC
- Standard O-rings and Cover Seals:	Buna
- Optional Faces:	Carbon, Ceramic
- Optional O-rings and Cover Seals:	FPM, EPDM, Silicone

TD 249-001

Double Mechanical Seals with Flush

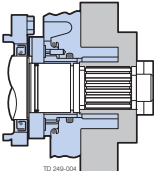

- Standard Seal Faces:	SiC/SiC
- Standard O-rings and Cover Seals:	Buna
- Optional Faces:	Carbon, Ceramic
- Optional O-rings and Cover Seals:	FPM, EPDM, Silicone

TD 249-004

Twin Wing Rotors Standard.
Provides minimum pulsation.

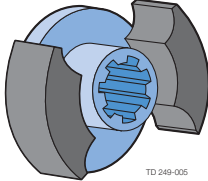

TD 249-005

Single Wing Rotors Optional.
Provides reduced shear on shear sensitive fluids or large solids such as fruit pieces, nut kernels, cheese curds or meats.

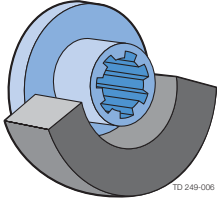

TD 249-006

Alfa Laval Positive Displacement Circumferential Piston Pumping Principle



Alfa Laval rotor wings (pistons) rotate around the circumference of the channel in the pump casing. This continuously generates a partial vacuum at the suction port as the rotors unmesh, causing fluid to enter the pump. The fluid is transported around the channel by the rotor wings, and is displaced as the rotor wings re-mesh, generating pressure at the discharge port. Direction of flow is reversible.

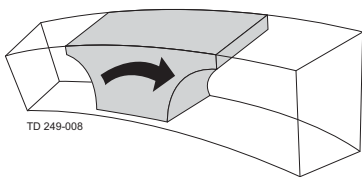

The deep channels in which the rotors travel provide large voids to minimize shear and bruising of solids.

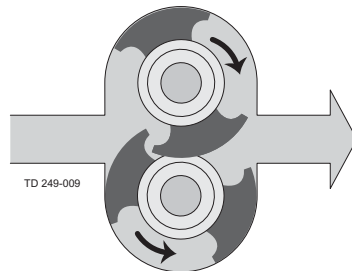

The rotors are made of non-galling alloy, allowing extremely tight clearances between rotating and stationary surfaces, which ensures high efficiency and metering accuracy, even on thin liquids.

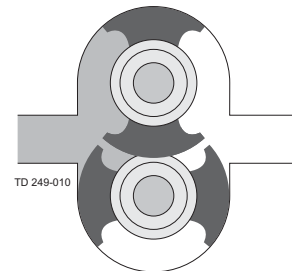

The hub of each non-galling rotor rotates in a recess in the pump head to minimize deflection even at high discharge pressures.

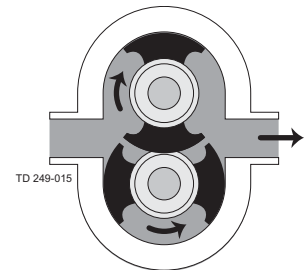
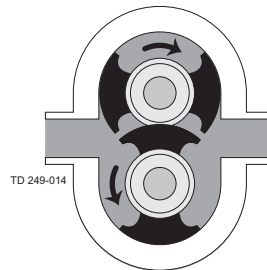
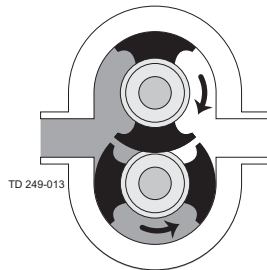
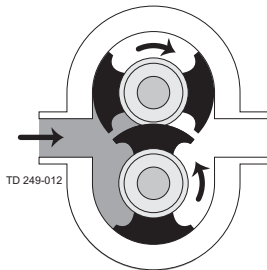

Suction

Discharge

Unique Cleaning and Maintenance Features

- Designed for easy strip cleaning, the pump casing is independently fastened to the gearbox to prevent damage to the seals when the cover is removed, and to allow the rotors to be turned while spraying down the fluid chamber
- Bearing retainers are stainless steel, not carbon steel, ensuring longer life under harsh cleaning conditions.
- Grease fittings are threaded, not pressed in, to prevent accidental removal during greasing.

Dimensions

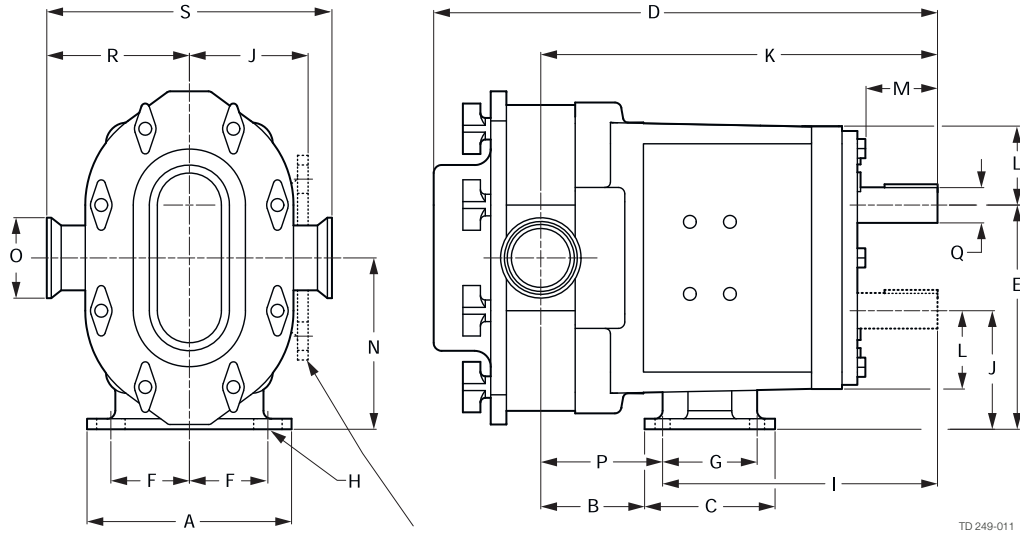

Optional foot location

TD 249-011

(mm)

Model	A	B	C	D	E	F	G	H	I	J	K	L	M	N	O	P	Q	R	S	Weight
006	121	59	81	303	140	49	59	9.5 x 8 (slot)	173	74	244	46	51	107	38	71	22.23	89	177	24 kg
015	121	59	81	303	140	49	59	9.5 x 8 (slot)	173	74	244	46	51	107	38	71	22.23	89	177	24 kg
018	121	59	81	316	140	49	59	9.5 x 8 (slot)	173	74	250	46	51	107	38	77	22.23	90	180	24 kg
030	159	71	108	369	174	61	65	11 x 11 (slot)	197	90	295	67	59	132	38	98	31.75	108	216	45 kg
045	210	105	149	480	243	89	105	14 x 13 (slot)	258	129	392	89	55	186	51	134	41.28	136	273	132 kg
060	210	105	149	480	243	89	105	14 x 13 (slot)	258	129	385	89	55	186	63	127	41.28	136	273	132 kg
130	210	122	149	499	243	89	105	14 x 13 (slot)	257	129	401	89	55	186	76	144	41.28	136	273	142 kg
220	216	129	229	592	314	95	184	14 x 5 (slot)	324	162	470	114	67	238	102	146	50.80	168	337	252 kg
320	305	105	295	766	353	133	203	16 ø	420	175	557	129	103	264	152	136	60.45	203	406	477 kg

(in)

Model	A	B	C	D	E	F	G	H	I	J	K	L	M	N	O	P	Q	R	S	Weight
006	4.75	2.34	3.20	12.04	5.50	1.94	2.31	0.375 x 0.31 (slot)	6.82	2.93	9.61	1.81	2.00	4.21	1.50	2.79	0.875	3.49	6.97	53 lb
015	4.75	2.34	3.20	12.04	5.50	1.94	2.31	0.375 x 0.31 (slot)	6.82	2.93	9.61	1.81	2.00	4.21	1.50	2.79	0.875	3.49	6.97	53 lb
018	4.75	2.34	3.20	12.46	5.50	1.94	2.31	0.375 x 0.31 (slot)	6.82	2.93	9.84	1.81	2.00	4.21	1.50	3.02	0.875	3.55	7.09	53 lb
030	6.25	2.78	4.25	14.52	6.86	2.42	2.56	0.438 x 0.44 (slot)	7.77	3.56	11.61	2.62	2.32	5.21	1.50	3.84	1.250	4.25	8.50	99 lb
045	8.25	4.14	5.87	18.91	9.56	3.50	4.12	0.56 x 0.50 (slot)	10.14	5.06	15.42	3.50	2.15	7.31	2.00	5.28	1.625	5.38	10.75	290 lb
060	8.25	4.14	5.87	18.73	9.56	3.50	4.12	0.56 x 0.50 (slot)	10.14	5.06	15.14	3.50	2.15	7.31	2.50	5.00	1.625	5.37	10.75	290 lb
130	8.25	4.79	5.87	19.66	9.56	3.50	4.12	0.56 x 0.50 (slot)	10.12	5.06	15.77	3.50	2.15	7.31	3.00	5.65	1.625	5.37	10.75	312 lb
220	8.50	5.07	9.00	23.29	12.38	3.75	7.25	0.56 x 0.19 (slot)	12.74	6.38	18.49	4.50	2.63	9.38	4.00	5.75	2.000	6.63	13.25	555 lb
320	12.0	4.12	11.63	30.17	13.88	5.25	8.00	0.66 ø	16.55	6.88	21.92	5.06	4.06	10.38	6.00	5.37	2.375	8.00	16.00	1050 lb

Alfa Laval reserves the right to change specifications without prior notification. ALFA LAVAL is a trademark registered and owned by Alfa Laval Corporate AB.

ESE01676EN 1201

© Alfa Laval

How to contact Alfa Laval

Contact details for all countries are continually updated on our website. Please visit www.alfalaval.com to access the information direct.